

Novato Ring 12', 16', 20' – Pendant

AIP12185 144.00 in

JOB NAME:

TYPE:

NOTES:

DESCRIPTION

A cornerstone of our luminous forms collection, Novato Ring is renowned for its uniform, three-sided illumination, versatility, and high performance. With efficacy over 100 lumens per watt delivered, it can often be the only light source needed in a space, providing both the aesthetics and performance you require. The luminaire's 5" cross-section is ideal for mid to high ceiling applications. It looks great individually or in patterns. We can also help you create interlocking, orbit, and tiered chandeliers. Novato Ring pendants are available in the widest range of sizes on the market – from 2' to 20'. Other sizes are available upon request.

FEATURES & BENEFITS

NEW! Wood Grain Finish band options available.

- Take your design to a new scale
- Fully enclosed three-sided luminous form brightens horizontal and vertical planes
- 70% direct/30% indirect distribution
- Provides functional lighting with comfortable luminance levels
- Specialized high-transmission diffuser offers higher delivered lumens while providing uniform illumination
- Crisp, clean edges give the shape clear definition
- Segmented for easy transportation and installation
- Add decorative accents with optional color bands
- Keep ceilings clean with minimal mounting hardware and just one power drop
- Handcrafted in USA

SPECIFICATIONS

- **LIGHT SOURCE:** White LED light engine (contact factory for RGBW or Tunable White)
- **CRI:** 80+ or 90+
- **LUMEN MAINTENANCE:** L80 = >72,000 Hrs.
- **EFFICACY:** 102 lm/W delivered
- **CCT:** 2700K, 3000K, 3500K, 4000K, 5000K
- **VOLTAGE:** 120-277V standard
- **DRIVER:** Integral Class 2 power supply



- **DIMMING:** 1% minimum dim level standard
- **CONTROLS:** 0-10V standard. Lutron Athena, Current NX, and nLight AIR optional. Contact factory for other controls (e.g., Enlighted, Encelium, Wattstopper, WaveLinx, or Casambi).
- **EMERGENCY:** Remote battery option is provided with 10W Constant Power Battery back-up, providing 90 Minutes of Emergency operation. Contact factory for other Emergency options.
- **CONSTRUCTION:** Edges are fused with solvent that permanently binds acrylic. Ships in eight segments. Segments are connected by powerful magnetics and secured with a mechanical connection. Plug & play wiring between sections expedites installation.
- **FINISH:** Canopy finished to match your specification. Choose from 26 standard thermoset polyester powder coat paint colors. RAL®, Pantone®, or custom finishes available upon request. Color band options are specified separately. The ring's top plate and channel are painted Super White (PT01).
- **MODIFICATIONS:** Consult factory for all modification requests, including RGBW or Tunable White, remote drivers, or 2"x2" cross-section rings
- **APPROVALS:** ETL listed to UL standards (US & Canada) for use in damp locations; not recommended for exterior applications

DIMENSIONS

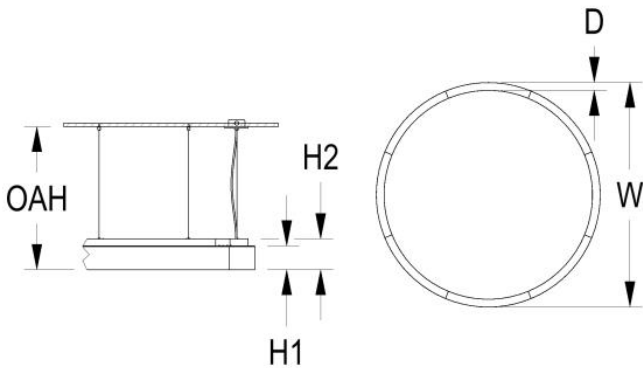

W	H1	H2	D	OAH
144 in	5 in	6.5 in	5 in	120 in
365.8 cm	12.7 cm	16.5 cm	12.7 cm	304.8 cm

Mounting Weight
Approximate: 120 lb (55 kg)

CONFIGURATOR

To configure your spec sheet online, go to www.spilighting.com/AIP12185. Not all options are available in all configurations; consult factory for details.

Required Field *

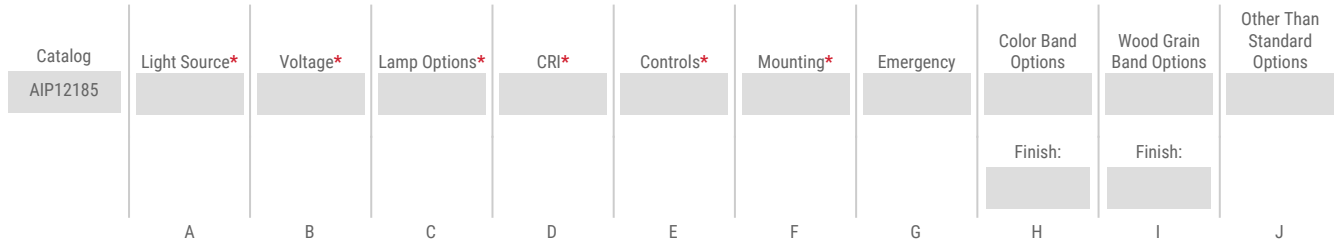

A - LIGHT SOURCE *

To ensure color consistency, SPI uses precise bin selection and strict quality processes to maintain a 3-step (MacAdam) SDCM on all white LED lampings. Published LED luminaire wattages are calculated using a typical power supply efficiency of 88%; exact wattages may vary based on application. Alternative wattages available upon request.

- L254W** | White 254W LED Light Engine | Delivered Lumens: 25,949
- L508W** | White 508W LED Light Engine | Delivered Lumens: 51,897

B - VOLTAGE *

- 120-277V** | Universal Voltage

C - LAMP OPTIONS *

Apply multiplier from chart for delivered lumens at other CCT's and CRI's.

- 2700K** | 2700K CCT
- 3000K** | 3000K CCT
- 3500K** | 3500K CCT
- 4000K** | 4000K CCT
- 5000K** | 5000K CCT

	80 CRI	90 CRI
2700K	1.00	0.84
3000K	1.00	0.84
3500K	1.00	0.84
4000K	1.00	0.84
5000K	1.00	0.84

2700K

D - CRI *

- DF_80** | (default)
- 90**

E - CONTROLS *

Extended lead times may apply for controls other than 0-10V. Contact factory for additional control options such as Enlighted, Encelium, Wattstopper, WaveLinx, Casambi, or others.

- DF_DIM1** | 0-10V Control, 1% Dimming (default)
- AWNR** | Lutron Athena Wireless Node, 1% Dimming
- NX** | Current NX Wireless, 1% Dimming
- NLTA** | Acuity nLight Air, 1% Dimming

F - MOUNTING *

Power drop canopy mounts to standard 4" octagonal junction box. Field adjustable aircraft cables allow fixture to be mounted at an application appropriate height (up to OAH). The aircraft ceiling coupler can be connected to power drop canopy or can be separated from the power drop canopy to gain flexibility in mounting. See Downloads on website for mounting center measurements. Aircraft cable suspension uses ceiling coupler to mount to structure above. Coupler accepts 1/4-20 threaded rod or can be anchored using through hole (hardware by others). Remote mounting options available; contact factory.

- DF_SIA** | 5" Flat Canopy, Integral Power Supply, 8 Straight Aircraft Cables & Power Cord (default)

G - EMERGENCY

10W, Constant Power Battery Back-up, with 90 minutes of emergency operation. EMR includes damp location enclosure for Battery back-up.

- EMR** | Emergency Battery Remote

H - COLOR BAND OPTIONS

Color bands are opaque. The finish is specified separately. When choosing this option, use the associated photometrics provided.

- MB01** ¹ | Color Band Inner (See last page for finish options)
- MB02** ² | Color Band Outer (See last page for finish options)
- MB03** ³ | Color Band Inner & Outer (See last page for finish options)

¹ Delivered lumens are 83% of luminous form output shown above

² Delivered lumens are 64% of luminous form output shown above

³ Delivered lumens are 53% of luminous form output shown above. To specify different finishes for the inner and outer color bands, consult factory.



I - WOOD GRAIN BAND OPTIONS

WG01 | Wood Grain Band Inner (See last page for finish options)

WG03 | Wood Grain Band Inner & Outer (See last page for finish options)

WG02 | Wood Grain Band Outer (See last page for finish options)

J - OTHER THAN STANDARD OPTIONS

Specify overall height required from ceiling to the bottom of the fixture.

OAH | Pendant suspension length other than standard Length:











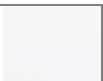

Standard Finishes

The colors shown are representative. Their actual appearance may vary due to differences in display settings. You can request color chips by emailing contact@spilighting.com. Please note, finishes may not be available in all configurations.

Wood Grain Finishes

Chocolate Pear		Ellmau Beech		Red Alder		Rustic Cherry		Shaker Cherry	
Tundra Birch									

Paint Colors

PT01 RAL9003 Signal White (Gloss)		PT51 Matte White (Textured)		PT02 White (Textured)		PT04 RAL9001 Cream (Textured)		PT67 RAL7044 Silk Grey (Textured)	
PT53 RAL7035 Light Grey (Textured)		PT54 RAL7037 Dusty Grey (Textured)		PT55 RAL7012 Basalt Grey (Textured)		PT56 RAL7016 Anthracite Grey (Textured)		PT11 Black (Textured)	
PT57 RAL1015 Light Ivory (Textured)		PT58 RAL8004 Copper Brown (Textured)		PT59 RAL6021 Pale Green (Textured)		PT60 RAL1019 Grey Beige (Textured)		PT61 RAL7006 Beige Grey (Textured)	
PT62 RAL1003 Signal Yellow (Textured)		PT63 RAL3001 Signal Red (Textured)		PT64 RAL6001 Emerald Green (Textured)		PT65 RAL5005 Signal Blue (Textured)		PT66 RAL5003 Sapphire Blue (Textured)	

Metallic Paint Colors

PT22 Platinum (Metallic Gloss)		PT48 Brass (Metallic Textured)		PT28 Dark Stainless (Metallic Gloss)		PT49 Bronze (Metallic Textured)		PT32 Dark Bronze (Metallic Gloss)	
PT46 Aluminum (Metallic Textured)									

Specialty Finishes



More RAL®, Pantone®, and custom finishes are available upon request. Setup fee and additional lead time applies. Call factory for details.