

Zynn 2" Ring - Pendant

AIP12208 98.00 in | Direct/Indirect

JOB NAME:

TYPE:

NOTES:

DESCRIPTION

Zynn 2" Ring is the complete tool kit for lighting professionals. This is the line to specify when you need aesthetics you can count on, a wide range of scales, and the performance capabilities to light a space effectively and comfortably.

FEATURES & BENEFITS

- Sleek 2" x 3" profile
- Create a well-balanced combination of indirect and direct light to increase visual comfort and improve light uniformity
- Get tight to the ceiling with the Close-Mount Indirect Batwing option
- Control up and down components independently
- Segmented for easy transportation and installation
- Clean, continuous lines of light with zero pixelation
- Superior fit and finish
- Keep ceilings clean with minimal mounting hardware
- Hidden internal aircraft cable grippers are easy to adjust
- Handcrafted in USA



SPECIFICATIONS

- **LIGHT SOURCE:** White LED light engine
- **DISTRIBUTION:** Direct/Indirect
- **CRI:** 80+ or 90+
- **LUMEN MAINTENANCE:** L80 = >60,000 Hrs.
- **EFFICACY:** Up to 115 lm/W delivered
- **CCT:** 2700K, 3000K, 3500K, 4000K, 5000K
- **VOLTAGE:** 120-277V standard
- **DRIVER:** Remote Class 2 power supply. Max distance to the driver (including OAH) is: #18 AWG = 50', #16 AWG = 75', #14 AWG = 100'. For extended distances, contact factory.
- **MAX AMBIENT OPERATING TEMP:** 42°C (108°F)
- **DIMMING:** 1% minimum dim level standard
- **CONTROLS:** 0-10V standard. Lutron Athena, Current NX, and nLight AIR optional. Contact factory for other controls (e.g.,

Enlighted, Encelium, Wattstopper, WaveLinx, or Casambi)

- **EMERGENCY:** Remote battery option is provided with 10W Constant Power Battery back-up, providing 90 Minutes of Emergency operation. Contact factory for other Emergency options.
- **INTEGRATED SURGE PROTECTION:** LED components are protected against minor surge events
- **DIFFUSER:** Matte opal acrylic (bottom). Frosted clear acrylic (top).
- **CONSTRUCTION:** 6000 series aluminum extrusion
- **FINISH:** Housing and mounting components finished to match. To specify separately, contact factory. Choose from 26 standard thermoset polyester powder coat paint colors or various metal finishes. RAL®, Pantone®, or custom finishes available upon request.
- **MODIFICATIONS:** Consult factory for all modification requests, including alternate sizes
- **APPROVALS:** ETL listed to UL standards (US & Canada) for use in damp locations; not recommended for exterior applications

DIMENSIONS

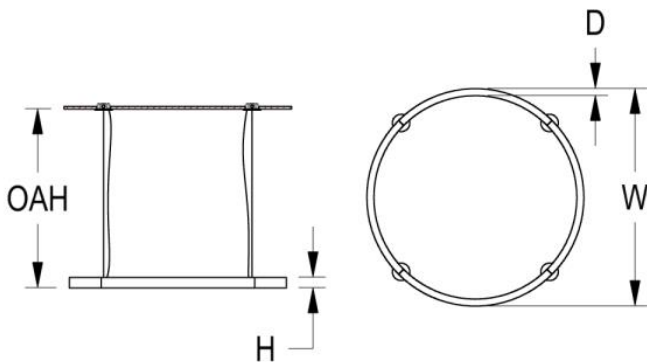

W	H	D	OAH
98 in	3 in	2 in	54 in
248.9 cm	7.6 cm	5.1 cm	137.2 cm

Mounting Weight

Approximate: 50 lb (23 kg)

CONFIGURATOR

To configure your spec sheet online, go to www.spilighting.com/AIP12208. Not all options are available in all configurations; consult factory for details.

Required Field *

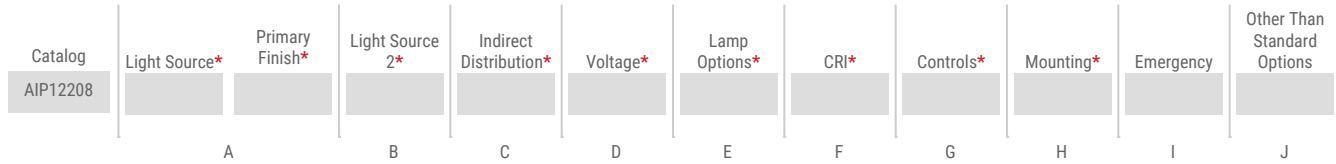

A - LIGHT SOURCE *

To ensure color consistency, SPI uses precise bin selection and strict quality processes to maintain a 3-step (MacAdam) SDCM on all white LED lampings. Published LED luminaire wattages are calculated using a typical power supply efficiency of 88%; exact wattages may vary based on application. Alternative wattages available upon request. Choose a DIRECT light source below:

- DIR-L85W** | White 85W LED Light Engine | Delivered Lumens: 6,112
- DIR-L169W** | White 169W LED Light Engine | Delivered Lumens: 12,151
- DIR-L339W** | White 339W LED Light Engine | Delivered Lumens: 24,374

See last page for finish options

B - LIGHT SOURCE 2 *

Choose an INDIRECT light source below:

- IND-L85W** | White 85W LED Light Engine (Delivered Lumens: 10,702)
- IND-L169W** | White 169W LED Light Engine (Delivered Lumens: 21,277)
- IND-L339W** | White 339W LED Light Engine (Delivered Lumens: 42,680)

C - INDIRECT DISTRIBUTION *

Choose the optical distributing for the indirect portion of the ring:

- DF_SME** | Symmetric (default)
- BW¹** | Batwing

¹ Delivered lumens are 90% of the output shown under Light Source 2.

D - VOLTAGE *

- 120-277V** | Universal Voltage

E - LAMP OPTIONS *

Apply multiplier from charts for delivered lumens at other CCT's and CRI's.

- 2700K** | 2700K CCT
- 3000K** | 3000K CCT
- 3500K** | 3500K CCT
- 4000K** | 4000K CCT
- 5000K** | 5000K CCT

	DIRECT LIGHT			INDIRECT LIGHT	
	80 CRI	90 CRI		80 CRI	90 CRI
2700K	n/a	0.84	2700K	1.00	0.84
3000K	n/a	1.00	3000K	1.00	0.84
3500K	n/a	1.00	3500K	1.00	0.84
4000K	n/a	1.00	4000K	1.00	0.84
5000K	n/a	1.00	5000K	1.00	0.84

F - CRI *

- 90**
- 80** | (default)

G - CONTROLS *

Extended lead times may apply for controls other than 0-10V. Contact factory for additional control options such as Enlighted, Encelium, Wattstopper, WaveLinx, Casambi, or others.

- DF_DIM1** | 0-10V Control, 1% Dimming (default)
- AWN²** | Lutron Athena Wireless Node, 1% Dimming
- NX²** | Current NX Wireless, 1% Dimming
- NLTA²** | Acuity nLight Air, 1% Dimming

² Not available with SCA mounting option.

H - MOUNTING *

Mounts to standard 4" octagonal junction box. Field adjustable cables allow fixture to be mounted at an application appropriate height (up to OAH).

- SRA** | 5" Flat Canopies & 4 Straight Aircraft Cables with 4 White Power Cords, Remote Supply
- SCA** | 12" Canopies with Power Supplies & 4 Straight Aircraft Cables with 4 White Power Cords

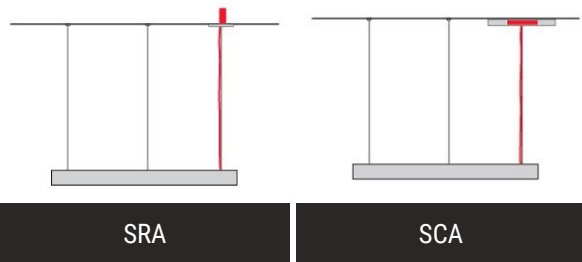

I - EMERGENCY

10W, Constant Power Battery Back-up, with 90 minutes of emergency operation. EMR includes damp location enclosure for Battery back-up.

EMR | Emergency Battery Remote

J - OTHER THAN STANDARD OPTIONS

Specify overall height required from ceiling to the bottom of the fixture.

OAH | Pendant suspension length other than standard Length:

Standard Finishes

The colors shown are representative. Their actual appearance may vary due to differences in display settings. You can request color chips by emailing contact@spilighting.com. Please note, finishes may not be available in all configurations.

Paint Colors

PT01 RAL9003 Signal White (Gloss)	PT51 Matte White (Textured)	PT02 White (Textured)	PT04 RAL9001 Cream (Textured)	PT67 RAL7044 Silk Grey (Textured)
PT53 RAL7035 Light Grey (Textured)	PT54 RAL7037 Dusty Grey (Textured)	PT55 RAL7012 Basalt Grey (Textured)	PT56 RAL7016 Anthracite Grey (Textured)	PT11 Black (Textured)
PT57 RAL1015 Light Ivory (Textured)	PT58 RAL8004 Copper Brown (Textured)	PT59 RAL6021 Pale Green (Textured)	PT60 RAL1019 Grey Beige (Textured)	PT61 RAL7006 Beige Grey (Textured)
PT62 RAL1003 Signal Yellow (Textured)	PT63 RAL3001 Signal Red (Textured)	PT64 RAL6001 Emerald Green (Textured)	PT65 RAL5005 Signal Blue (Textured)	PT66 RAL5003 Sapphire Blue (Textured)

Metallic Paint Colors

PT22 Platinum (Metallic Gloss)	PT48 Brass (Metallic Textured)	PT28 Dark Stainless (Metallic Gloss)	PT49 Bronze (Metallic Textured)	PT32 Dark Bronze (Metallic Gloss)
PT46 Aluminum (Metallic Textured)				

Brushed Aluminum

BAL Brushed Aluminum	MAL Microbrushed Aluminum
--------------------------------	-------------------------------------

Specialty Finishes



More RAL®, Pantone®, and custom finishes are available upon request. Setup fee and additional lead time applies. Call factory for details.