

Paris - Pendant & Chandelier

AIP8648 33.20 in | (2) Bowl

JOB NAME:

TYPE:

NOTES:

DESCRIPTION

Our swept bowl collection offers unique styling and graceful lines. This low-profile series offers exceptional high-output lamping optics for low to mid-height ceiling applications. The family includes pendant, chandelier, wall-mounted, and ceiling models to illuminate and enhance the visual environment you're creating.

FEATURES & BENEFITS

- Opal acrylic diffuser lens enhances a space with filtered illumination
- Spun metal trim ring adds high-quality, decorative element to fixture
- Handcrafted in USA

SPECIFICATIONS

- **LIGHT SOURCE:** White LED light engine
- **CRI:** 80+ or 90+
- **LUMEN MAINTENANCE:** L70 = >50,000 Hrs.
- **CCT:** 2700K, 3000K, 3500K, 4000K, 5000K
- **DRIVER:** Integral Class 2 power supply standard
- **DIMMING:** 0-10V controls standard to 10% on LED light engines
- **CONTROLS:** Contact factory for control options (e.g., Lutron Athena, Current NX, nLight, Enlighted, Encelium, Wattstopper, WaveLinx, or Casambi)
- **EMERGENCY:** Remote battery option is provided with 10W Constant Power Battery back-up, providing 90 Minutes of Emergency operation. Contact factory for other Emergency options.
- **CONSTRUCTION:** Formed metal construction provides durable protection for internal components and is recyclable
- **DIFFUSER:** Opal acrylic is standard; matte acrylic and hand painted lenses optional. Any upward facing LEDs will be covered with a protective lens.
- **MODIFICATIONS:** Consult factory for all modification requests
- **APPROVALS:** ETL listed to UL standards (US & Canada) for use in damp locations; not recommended for exterior applications



EMR

DIMENSIONS

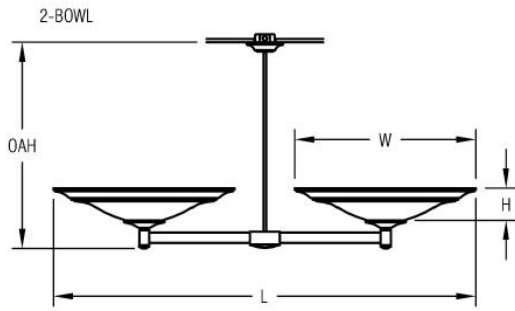

W	H	OAH	L
33.2 in	5.8 in	45 in	77.7 in
84.3 cm	14.7 cm	114.3 cm	197.4 cm

Mounting Weight
Approximate: 150 lb (69 kg)

CONFIGURATOR

To configure your spec sheet online, go to www.spilighting.com/AIP8648. Not all options are available in all configurations; consult factory for details.

Required Field *

Catalog	Light Source*	Primary Finish*	Voltage*	Lamp Options*	CRI*	Diffuser*	Mounting*	Emergency	Options	Other Than Standard Options
AIP8648										
	A		B	C	D	E	F	G	H	I
									Finish:	

A - LIGHT SOURCE *

To ensure color consistency, SPI uses precise bin selection and strict quality processes to maintain a 3-step (MacAdam) SDCM on all white LED lampings. Published LED luminaire wattages are calculated using a typical power supply efficiency of 88%; exact wattages may vary based on application.

- (2) L86W** | (2 HEAD) White 86W LED Light Engine | Delivered Lumens: 17,031
- (2) L172W** | (2 HEAD) White 172W LED Light Engine | Delivered Lumens: 34,062

See last page for finish options

B - VOLTAGE *

- 120-277V** | Universal Voltage

C - LAMP OPTIONS *

Apply multiplier from chart for delivered lumens at other CCT's and CRI's.

- 2700K** | 2700K CCT
- 3000K** | 3000K CCT
- 3500K** | 3500K CCT
- 4000K** | 4000K CCT
- 5000K** | 5000K CCT

	80 CRI	90 CRI
2700K	1.00	0.84
3000K	1.00	0.84
3500K	1.00	0.84
4000K	1.00	0.84
5000K	1.00	0.84

D - CRI *

- DF_80** | (default)
- 90**

E - DIFFUSER *

- DF_OA** | Opal Acrylic Diffuser Lens (default)
- HP01** | Silver Hand Painted Acrylic Diffuser
- HP02** | Beige Hand Painted Acrylic Diffuser
- HP03** | Amber Hand Painted Acrylic Diffuser
- MA01** | Matte Acrylic Diffuser Lens



F - MOUNTING *

Mounts to standard 4" octagonal junction box with auxiliary mounting holes. Additional support required (by others). Canopy is 6.5" diameter with a 45 degree swivel.

- DF_STM** | Stem Mount (default)

G - EMERGENCY

10W, Constant Power Battery Back-up, with 90 minutes of emergency operation. EMR includes damp location enclosure for Battery back-up.

EMR | Emergency Battery Remote

H - OPTIONS

- KC01** | Chain Kit (to Transition Plate) (See last page for finish options)
- KR01** | Angled Stem Multi Kit (to Transition Plate) (See last page for finish options)
- KS01** | Straight Stem Multi Kit (to Transition Plate) (See last page for finish options)
- F** | Fusing

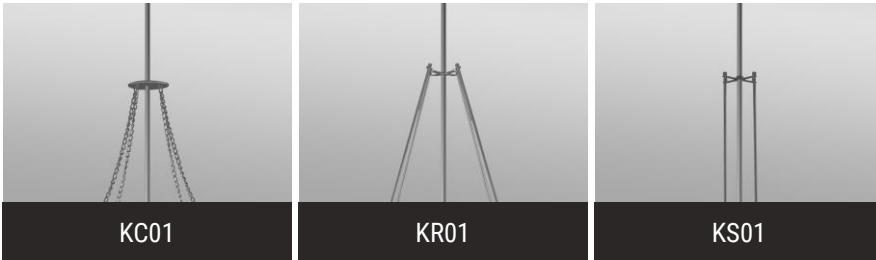

I - OTHER THAN STANDARD OPTIONS

Specify overall height required from ceiling to the bottom of the fixture.

OAH | Pendant suspension length other than standard

Standard Finishes

The colors shown are representative. Their actual appearance may vary due to differences in display settings. You can request color chips by emailing contact@spilighting.com. Please note, finishes may not be available in all configurations.

Paint Colors

PT01 RAL9003 Signal White (Gloss)	PT51 Matte White (Textured)	PT02 White (Textured)	PT04 RAL9001 Cream (Textured)	PT67 RAL7044 Silk Grey (Textured)
PT53 RAL7035 Light Grey (Textured)	PT54 RAL7037 Dusty Grey (Textured)	PT55 RAL7012 Basalt Grey (Textured)	PT56 RAL7016 Anthracite Grey (Textured)	PT11 Black (Textured)
PT57 RAL1015 Light Ivory (Textured)	PT58 RAL8004 Copper Brown (Textured)	PT59 RAL6021 Pale Green (Textured)	PT60 RAL1019 Grey Beige (Textured)	PT61 RAL7006 Beige Grey (Textured)
PT62 RAL1003 Signal Yellow (Textured)	PT63 RAL3001 Signal Red (Textured)	PT64 RAL6001 Emerald Green (Textured)	PT65 RAL5005 Signal Blue (Textured)	PT66 RAL5003 Sapphire Blue (Textured)

Metallic Paint Colors

PT22 Platinum (Metallic Gloss)	PT48 Brass (Metallic Textured)	PT28 Dark Stainless (Metallic Gloss)	PT49 Bronze (Metallic Textured)	PT32 Dark Bronze (Metallic Gloss)
PT46 Aluminum (Metallic Textured)				

Brushed Aluminum

BAL Brushed Aluminum

Brushed Brass

BBR Brushed Solid Brass

Polished-Tinted Brass

ATBR Antique Tinted Brass	DTBR Dark Tinted Brass	PBR Polished Brass
-------------------------------------	----------------------------------	------------------------------

Plated Steel

ANST Antique Brass Plated Steel	BBST Brushed Brass Plated Steel	CPST Chrome Plated Steel	PBST Polished Brass Plated Steel	SNST Satin Nickel Steel
---	---	------------------------------------	--	-----------------------------------

Polished Plated Brass

CPBR Chrome Plated Polished Brass	SNBR Satin Nickel Plated Brass
---	--

Specialty Finishes



More RAL®, Pantone®, and custom finishes are available upon request. Setup fee and additional lead time applies. Call factory for details.